

Since 1984

Boulder

255 South Taylor Avenue Louisville, Co 80027 U.S.A Tel: 303-495-2267 E-mail: sales@boulderamp.com Web: www.boulderamp.com



1162 Stereo Power Amplifier

Boulder Amplifiers, Inc.
255 S. Taylor Avenue
Louisville, CO 80027
(303) 495-2260
www.boulderamp.com
f BoulderAmplifiersInc
i @boulderamplifiers
X @BoulderAmps

ABOUT

About Boulder Amplifiers, Inc.

Boulder was founded in 1984 and is the last high-performance audio manufacturer operating in North America to still perform all of its own design, engineering and manufacturing in-house. While this form of production may be more costly than outsourcing, the resulting quality control and reliability of the finished products are never compromised.

In 2016, Boulder moved into a new, purpose-built production facility to increase manufacturing efficiency and offer space for expansion to meet the needs of future growth.



THANK YOU

Congratulations and thank you for selecting the Boulder 1162 Stereo Power Amplifier for your high-performance sound system. We are certain it will provide you with many years of listening pleasure.

The 1162 represents the concerted efforts of numerous Boulder designers, engineers, and technicians working to bring you the best audio playback components in the world. Please take a few minutes to read through this instruction manual prior to using your 1162. This will help you understand the many functions and capabilities of the device. It will also allow you to maximize the convenience and performance for which it was engineered.

Your Boulder 1162 has undergone extensive laboratory tests for safety, functionality and technical excellence. In addition, it has been individually subjected to rigorous listening trials in our sound room utilizing a wide range of musical material. No product ever leaves our factory until we are totally satisfied that it achieves its full potential.

Table of Contents

About	- - - - -	- 1-1
Thank You	- - - - -	- 2-2
Introduction	- - - - -	- 3-5
	Placement of the 1162 Mono Power Amplifier	3-5
Connections	- - - - -	- 3-6
	Connecting to a Network	3-6
	Connecting to a Balanced Source	3-6
	Connecting to an Unbalanced Analog Source	3-7
	Connecting to the AC Mains Outlet	3-8
	Connecting Your Loudspeakers	3-9
Operation	- - - - -	- 3-10
	Powering Up	3-10
	Input DC Offset Voltage Detection	4-11
	Clip Detection	4-11
	Thermal Protection	4-11
	Maintenance	4-12
	Errors Requiring Boulder Dealer Service	4-12
	Operational Errors	4-12



Programming - - - - - 4-13

HTML Programming 4-13

Appendix - - - - - 5-14

Technical Specifications 5-14

Weights and Dimensions 5-15

1162 Stereo Power Amplifier Dimensions 5-16

Troubleshooting 5-17

Notes: 5-18

INTRODUCTION

Placement of the 1162 Mono Power Amplifier

Your Boulder 1162 Stereo Power Amplifier is designed to reduce interference from external magnetic and radio frequency fields (RF). While placement is not critical, known magnetic fields should be avoided.

The 1162 Stereo Power Amplifier will generate some heat. Therefore, it should be located in an area with ample air circulation. Specifically, be certain that the heat sinks are unobstructed by objects that could potentially block airflow. Do not place the amplifier on deep carpet and be sure that the amplifier has a minimum of 3 inches (8 cm) of free airspace on all sides.

You may want to have access to the rear panel for cable changes. Although input cables can be as long as necessary, it is suggested that speaker cables be as short as possible.

CONNECTIONS

Connecting to a Network

In order for the 1162 to download software updates as necessary, it will need to be connected to a network with an active Internet connection. Connect a network cable between the 1162 and a network router or switch. Use the Ethernet connector on the rear panel of the 1162.

Connecting to a Balanced Source

To fully realize the sonic potential of your 1162 Stereo Power Amplifier, always use balanced connections. Balanced cables minimize interference from magnetic and RF sources.

Connect the cables from your source or preamplifier outputs to the input connections provided on the rear panel of the 1162.

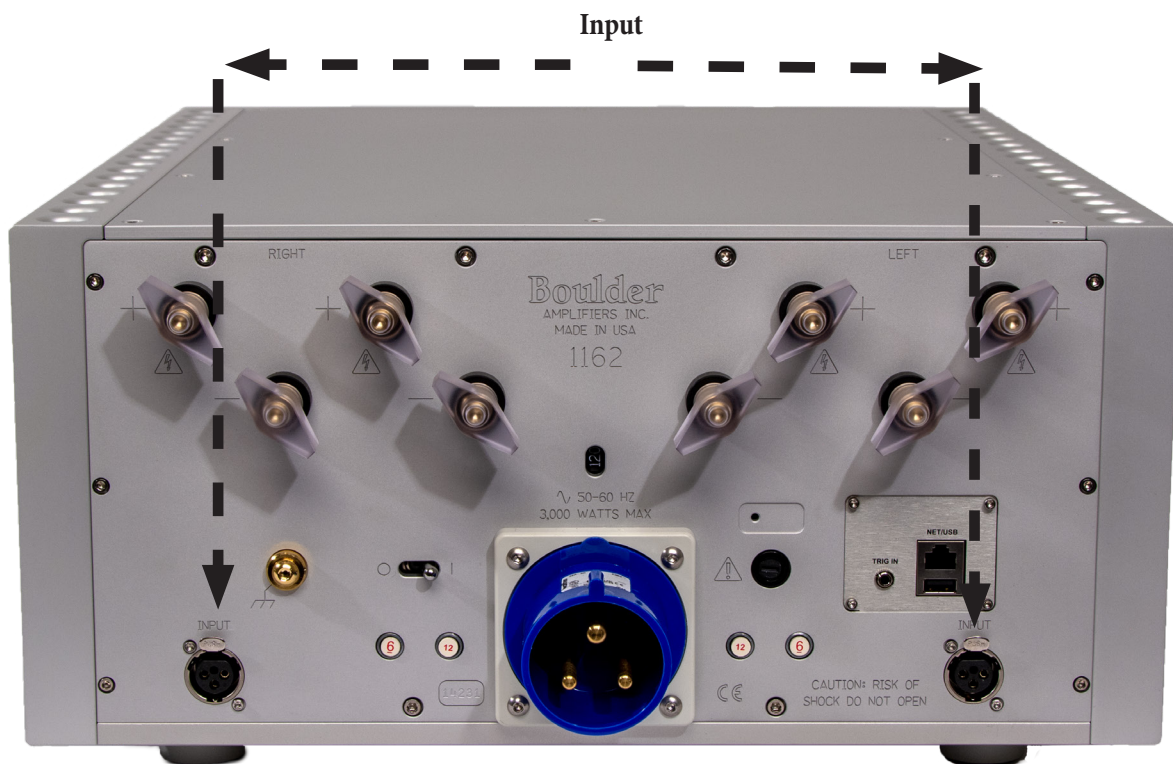

CONNECTIONS

Connecting to an Unbalanced Analog Source

Although the inputs and outputs are all of the 3-pin XLR type, an unbalanced source can easily be accommodated by using an unbalanced to balanced cable. This cable has an RCA phono-type connector on the source end and a 3-pin XLR connector for the input/output on the 1162 end.

The negative input (pin 3) should be wired to ground only at the RCA phono connector. This brings the inverted input reference of the 1162 to the unbalanced source ground, thus reducing ground loops.

Another option for connecting unbalanced sources is the Boulder ABL2 input adapter. It converts a balanced input into an RCA phono input at the rear of the 1162. Like the above cable, the negative input of the 1162 is connected to the ground of the RCA phono. However, this negative side will then share the shield wire with the chassis ground and will not have the best hum rejection.

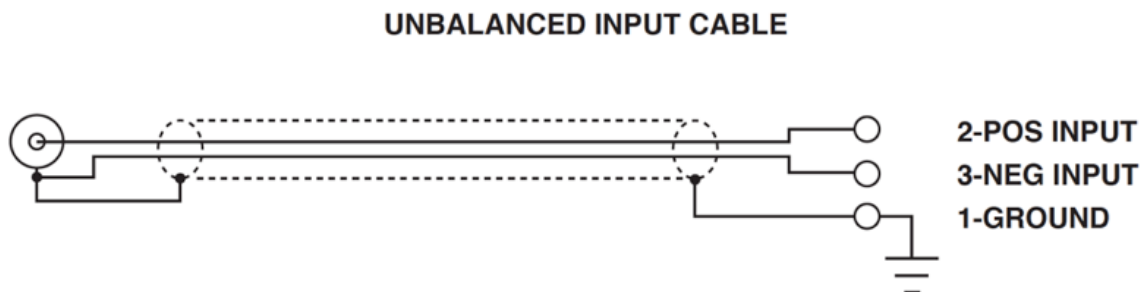

CONNECTIONS

Connecting to the AC Mains Outlet

Your 1162 Stereo Power Amplifier is supplied with a mains power cable suitable for the location where it was purchased. It is constructed of large enough wire gauge and a plug appropriate for your AC line voltage. Do not substitute another power cable.

Exact voltage and frequency compatibility is stated in the specifications section. See page 5-14.

Once the 1162 Stereo Power Amplifier is connected to a live mains outlet and the rear panel switch is moved to the “On” position, the LED on the front panel will illuminate red for a short time. During this time the 1162 is booting up. The LED will then pulse white on and off, indicating that the supervising microprocessor is powered up and the amp is ready to be turned on using the front panel Standby button.



CONNECTIONS

Connecting Your Loudspeakers

Do not use a wrench or any other type of tool on the output terminal binding posts. Tighten these connectors by hand only.

WARNING: This is a high-powered amplifier! There is high voltage potential at the terminals when driven. Connections should only be made with the AC mains disconnected!

Select speaker cable spade terminals that will accept .250-inch (6 mm) diameter binding posts.

Note: There is no provision for the use of banana plugs. Banana plugs are proven to lose spring tension and come loose over time, increasing contact resistance and distortion. We also do not recommend the use of banana plugs at the speaker end for these reasons.

Outputs



OPERATION

Powering Up

With all connections made, you are ready to listen to your Boulder 1162 Stereo Power Amplifier.

To turn the amplifier on, turn the rear panel **Master AC Switch** to the **ON** position. The amplifier will go through a turn-on sequence, during which time the power LED will illuminate **red**.

After about 20 seconds the LED will then slowly pulse white on and off, indicating that the supervising microprocessor is powered up. At this time, press the front panel button to bring the unit out of Standby mode.

Because of the large inrush currents associated with the large toroidal transformer, power relays are used to turn on the amplifier. These are under control of the supervising ARM processor. During the power up sequence, you will hear two sets of two relay clicks, separated by intervals of two seconds.

Once powered up, the front panel LED will steadily glow **white** to indicate normal operation.

To turn the amplifier off, press the **Standby** button again. The indicator will then slowly and continuously change from **white**, to **dark**, and back to **white**. This indicates that the amplifier is in Standby mode.

NOTE: Because the 1162 greatly reduces power consumption when in Standby mode, it is only necessary to place the amplifier in Standby when not in use. You do not need to turn the 1162 off via the Master AC Switch on the rear panel. The 1162 was designed for years of operation in this manner and no damage to the unit will occur.

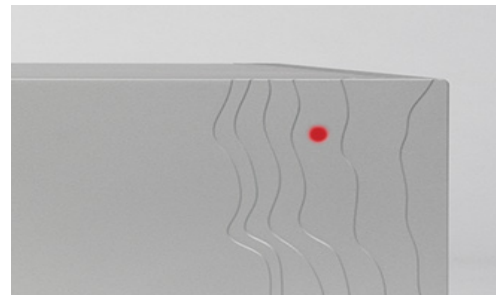
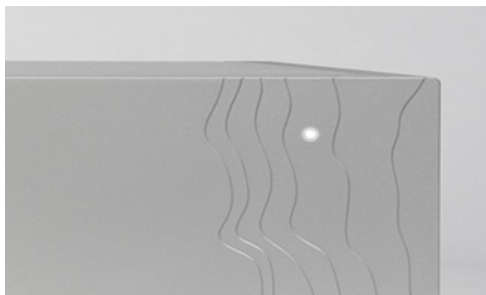

OPERATION

Input DC Offset Voltage Detection

The Boulder 1162 is a direct-coupled power amplifier with a servo for zeroing out DC voltage offset coming from the preamplifier or other sources connected to the amplifier's input.

If the DC at the inputs is sufficient to cause potentially damaging voltage at the output terminals, a protection circuit will mute the amplifier's output by electronically disconnecting the loudspeakers. The front panel LED will also turn **red**. This condition will continue until the source of DC is corrected or removed.

If the indicator remains **red**, it is recommended that the user correct the DC offset of the source device before continuing.

Clip Detection

Clipping of the waveform results when any amplifier is driven beyond its rated power. A clip detection circuit is included for protection in the 1162 Stereo Power Amplifier.

The front panel LED will indicate clipping by momentarily turning from **white** to **red**. Both voltage and current modes of clipping are detected, although it is generally only voltage clipping that occurs.

Thermal Protection

A thermal protection circuit prevents high operating temperatures that are unpleasant to the touch and potentially harmful to the amplifier. A thermal cutout circuit will mute the amplifier when the transistor cases reach 70°C, and the front panel LED will turn **red**. If this happens, the output level of the system should be reduced and more ventilation should be provided for the amplifier. Once the amplifier temperature cools to 60°C operation may resume.

OPERATION

Maintenance

No routine maintenance is required for the 1162 Stereo Power Amplifier. However, to keep operating temperatures at a minimum, be sure that the heat sinks are not obstructed and remove any dust buildup that may occur.

Errors Requiring Boulder Dealer Service

If the 1162 Stereo Power Amplifier will not turn on and the front panel LED blinks red, an error requiring dealer service has occurred. The indicator may flash red in a specific sequence to define its error code for an authorized Boulder technician. If you are experiencing this problem with your 1162, contact your Boulder dealer immediately.

Operational Errors

At times the 1162's front panel LED may flash red but continue operating normally. This is an Operational Error and indicates that there is a fault somewhere else in the system or in the use of the amplifier.

Conditions that will be indicated as Operational Errors may include:

- DC offset at the input of the amplifier (from a source or preamplifier)
- Thermal limit or safe operating temperature of the amplifier exceeded
- Clipping of the output signal

PROGRAMMING

HTML Programming

Though it is not necessary to use any of the HTML programming functions, you may find them helpful in setting up and personalizing your 1162.

All HTML programming is accomplished by accessing the 1162 HTML page while the unit is powered up and connected to a live computer network. Once the page is accessed, the various programming functions can be viewed, changed, and saved.

To access the 1162's HTML page, you will need a computer, phone or tablet that is connected to the same network as the 1162 to enter the 1162's network address into a web browser.

To find the 1162's network address, go into settings on the Boulder Controller App, then press the **System Settings** button in the Settings menu, followed by the **Network Settings** button. You will see a list of information about the 1162, including:

MAC Address:

Network Address:

SSID: BoulderAmplifiers-(serial number)

Network Address: If the 1162 is attached to an active network, the network address or IP address of the unit will be indicated here. This number should be entered in the address bar of a web browser to access the 1162's HTML programming page. The HTML page will then load onto your browser.

APPENDIX

Technical Specifications

Continuous Power, 8 Ohms	300W
Peak Power, 8 Ohms	450W
Peak Power, 4 Ohms	900W
Peak Power, 2 Ohms	1000W
THD, 8 Ohms 250W	0.002%, 20kHz: 0.01%
THD, 4 Ohms 250W	0.002%, 20kHz: 0.01%
THD, 2 Ohms 250W	0.003%, 20kHz: 0.02%
Equivalent Input Noise (EIN), 20 kHz, BW	2.2 μ V
Magnitude Response, 20 Hz to 20 kHz	+0.00, -0.04 dB
Frequency Response, -3 dB	0.015 Hz & 150 kHz
Voltage Gain	26 dB
Input Impedance	200k Ω Balanced 100k Ω Unbalanced
Balanced Analog Inputs	Balanced 3 pin XLR
Outputs	.25" (6 mm) Binding Posts
Power Requirements (Country Specific configured)	100V, 120V, 240V 50-60Hz
Power Consumption	3000W Max, 10W Standby 120W Idle

Note: All measurements taken at 120V

APPENDIX

Weights and Dimensions

**1162 Stereo Power Amplifier Chassis: 18" W x 16.43" D x 7.2" H
(54 lbs)**

**45.7 cm W x 41.7 cm D x 18.3 cm H
(24.5 kg)**

Shipping:

**24" W x 23" D x 14" H
(64 lbs)**

**61 cm W x 59 cm H x 36 cm H
(29 kg)**

APPENDIX

1162 Stereo Power Amplifier Dimensions

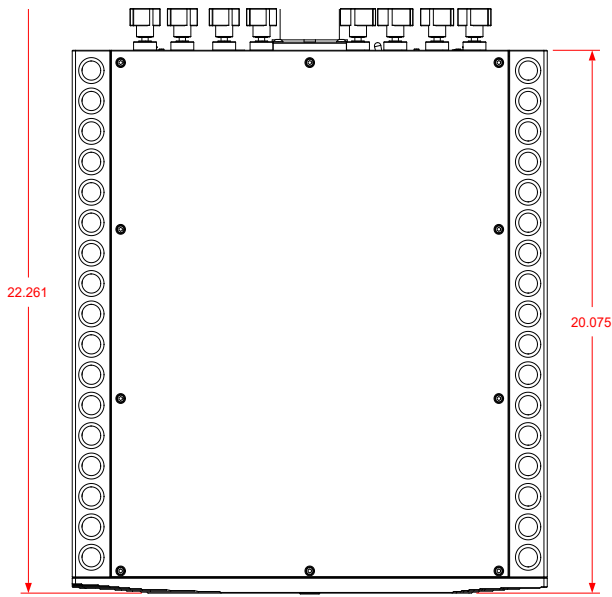

BOULDER 1162
STEREO POWER AMPLIFIER
DIMENSIONS

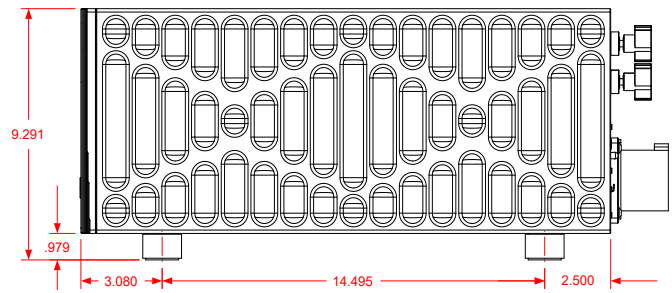
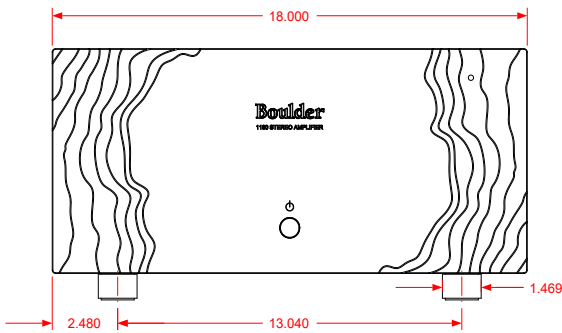

APPENDIX

Troubleshooting

SYMPTOM	CAUSE	REMEDY
No Power Indication	Rear panel power switch is not on	Turn on power switch
	Power amplifier is not plugged in	Connect to AC Mains outlet
	Amp Rear panel fuse is blown	Replace blown fuse with same type / rating
	Home circuit breaker is tripped	Reset home circuit breaker
Red Power Indication	Low line voltage	Reset breaker on rear panel
	Thermal protection	Let amp cool and improve ventilation
	Clipping protection	Lower pre-amp volume and reset rear breaker if necessary
	DC on input	Correct the DC issue in source or preamp
	Defective Power Supply	Return Amp to dealer for service
White power indication, but no sound from one channel	No signal from one channel of source	Check source controls, cables, and connections
	One channel is muted by balance control	Re-center balance on preamp
	No signal out to power amplifier	Check connections from preamplifier
Front panel LED flashes white and red and no output	Amplifier has detected a fatal error	Return to dealer for service

