



## 2108 Phono Preamplifier

12/22/2018  
Rev. 1.0

P/N: 91057

Boulder Amplifiers, Inc.  
255 S. Taylor Ave.  
Louisville, CO 80027  
(303) 449-8220  
[www.boulderamp.com](http://www.boulderamp.com)  
[www.facebook.com/BoulderAmplifiersInc](https://www.facebook.com/BoulderAmplifiersInc)

# About

---

## About Boulder Amplifiers, Inc.

Boulder was founded in 1984 and is the last high-performance audio manufacturer operating in North America to still perform all of its own design, engineering and manufacturing in-house. While this form of production may be more costly than outsourcing, the resulting quality control and reliability of the finished products are never compromised.

In 2016, Boulder moved into a new, purpose-built production facility to increase manufacturing efficiency and offer space for expansion to meet the needs of future growth.



# Thank You

---

Congratulations and thank you for selecting the Boulder 2108 Phono Preamplifier for your high-performance sound system. We are certain it will provide you with many years of listening pleasure.

The 2108 represents the concerted efforts of numerous Boulder designers, engineers, and technicians working to bring you the best audio playback components in the world. Please take a few moments to read through this instruction manual prior to using your 2108. This will help you understand the many functions and capabilities of the phono preamplifier. It will also allow you to maximize the convenience and performance for which it was engineered.

Your Boulder 2108 Phono Preamplifier has undergone extensive laboratory tests for safety, functionality and technical excellence. In addition, it has been individually subjected to rigorous listening trials in our sound room utilizing a wide range of musical material. No product ever leaves our factory until we are totally satisfied that it achieves its full potential.

# Table of Contents

---

## Getting Started

<b>Introduction</b>	1-1
Audio Features	1-1
Operational Features	1-1
Unpacking and Care	1-2
Before You Start	1-3
How to Clean the Casework	1-4
<b>Installation</b>	1-5
Placement and Installation	1-5
<b>Connections</b>	1-6
Making Connections to the 2108 Phono Preamplifier	1-6
Making Connections to the 2100 Power Supply	1-7
Connecting the 2108 to the 2100 Power Supply	1-8
Connecting the Analog Outputs	1-9
Connection to AC Mains	1-10
Turntable Connection Types	1-11
Connecting a Turntable	1-12
GROUND	1-13
Connecting a Cartridge Demagnetizer	1-14
Connecting the Outputs to a Balanced Preamplifier	1-15
Connecting the Outputs to an Unbalanced Preamplifier	1-16
<b>Setup and Loading</b>	1-17
Personality Cards	1-17
Moving Coil or Moving Magnet Selection	1-18
Cartridge Loading Adjustment - Resistive	1-19
Cartridge Loading Adjustment - Capacitive	1-22
Gain Selection Adjustment	1-23
Demagnetizer Pass-Through Selection	1-24

## Operation

Power	2-1
Standby	2-2
Mute	2-3
Input Selection	2-4
Demag	2-5
Mono	2-6
Equalization	2-7
Low Cut Filter	2-10
Connections	2-11

# Table of Contents

---

## Appendix

Technical Specifications .....	3-1
Dimensions & Weights .....	3-2
2108 Preamplifier Section Dimensions .....	3-3
2100 Power Supply Section Dimensions .....	3-4
Troubleshooting .....	3-5
Notes .....	3-7

# Getting Started

The 2108 Phono Preamplifier embodies years of development and is the evolution of the legendary 2008 Phono Preamplifier, one of the greatest phono preamplifiers ever made. Here are some of the features that set the 2108 apart from the competition:

## Audio features:

- Fully-balanced inputs and outputs.
- Surface-mount design (SMD) circuitry wherever possible.
- Three pairs of balanced inputs and two pairs of balanced outputs on XLR connectors.
- Boulder's own discrete 99S and 995S gain stages.
- Fully-adjustable resistive and capacitive load settings to match a wide range of phono cartridges.
- Standard RIAA equalization as well as EMI, Columbia, and FFRR (London/Decca) for records produced before 1955.

## Operational features:

- Fully-machined, non-resonant chassis design.
- Switchable gain for MC (moving coil) or MM (moving magnet) cartridges.
- Logic control to reduce operational noise.
- Mono mode to optimize monaural playback with stereo cartridges
- Four power supplies (Standby, analog left, analog right, and control) in a separate power supply enclosure.

# Getting Started

---

## Unpacking and Care

The 2108 Phono Preamplifier comes in two boxes and both are very heavy. They feature finely finished casework. Please use care when unpacking, lifting, and installing the two sections to avoid damage to the metalwork and furniture. The 2108 Phono Preamplifier weighs 37 lbs. (16.8kg) and the Power Supply weighs 48 lbs. (21.8 kg).

The Power Supply section is front-end heavy. Please be aware of this when lifting it to avoid any accidental damage.

Be sure to save all packing materials! The 2108 is shipped in a foam wrap to protect the fine finish of both sections. Try not to damage this wrap in the event that the unit must be transported in the future.

# Getting Started

## Before You Start

The 2108 system comes in two assemblies that must be put in place and connected: the 2108 Audio section and the 2100 Power Supply section.

You should have received two large, heavy boxes. The pieces included inside them are:

1. 2108 Audio section
2. 2100 Power Supply section
  - 1 x AC power cord
  - Accessory box #1 containing:
    - 3 x DC cables
3. Accessory box #2 containing:
  - Owner's Manual
  - PHRCA RCA-to-XLR Adaptors
  - Two spare Personality Cards with labels
  - Ground wire

If any of these pieces are missing or damaged, please contact your dealer immediately and before continuing the installation.



# Getting Started

---

## How to Clean the Casework

If the 2108 must be cleaned, use only a soft, lint-free cloth moistened with plain water.

**Never** use any type of chemical cleaner unless recommended by your dealer or the Boulder factory.

**Do not use bleach!** Bleach will remove the anodized surface of the casework.

**Never** use any type of abrasive to clean the casework.

If you have any questions, please contact your authorized Boulder dealer.

# Getting Started

## Installation

### Placement and Installation

Your Boulder 2108 Phono Preamplifier is designed to reduce the effects that external magnetic fields and radio frequencies (RF) have on its circuitry. While placement is not critical, because of the high gain of the 2108, known magnetic fields should be avoided whenever possible. Power transformers in other pieces of nearby equipment should be placed a minimum of 12 inches (30 cm) away.

Because it is very heavy, the 2108 must be placed on a sturdy, stable surface.

Do not place in an enclosed rack without ventilation. Both sections of the 2108 must have at least 2 inches (5 cm) of airspace around the chassis for proper cooling and airflow.

Be sure to leave access to the AC mains and DC power cables when installing. Depending on how easy it is to access the back panels of the 2108 and 2100, it may be wise to preinstall the power and interconnect cables before placement.

# Getting Started

## Connections

### Making Connections to the 2108 Phono Preamp



#### Input Connections

1. Input 1
2. Input 2
3. Input 3
4. Ground (or Earth) Binding Posts
5. Cartridge Demagnetizer Pass-through

#### Output Connections.

6. Right Outputs
7. Left Outputs

#### Power Supply Connections.

8. Power R Audio
9. Power L Audio
10. Power Digital (Control)

# Getting Started

## Making Connections to the 2100 Power Supply



1. AC Mains Connection
2. Master AC Power Switch
3. Right Audio DC Power
4. Left Audio DC Power
5. Digital (Control) DC Power

# Getting Started

---

## Connecting the 2108 to the 2100 Power Supply

Connect the DC cables from the 2100 power supply to the 2108 Phono Preamplifier. Because the cable connectors are keyed, they cannot be installed incorrectly.

Please note that the Digital (Control) DC cable has a different number of pins and cannot be connected to the Audio power connectors.

**WARNING:** Do not turn on the 2100 until all DC power connections have been made!

*It is important never to disconnect any of the DC power cables when the unit is powered ON via the AC master power switch or damage may occur, even when the 2108 is in Standby mode!*

*Always turn the unit **OFF** from the rear panel of the 2100 power supply before disconnecting any of the DC power cables.*

# Getting Started

## Connecting the Analog Outputs

Connect the left and right interconnect cables from one of the 2108's **LEFT OUTPUTS** and **RIGHT OUTPUTS** to your preamplifier or integrated amplifier's left and right input connections. To maintain best sound quality, Boulder recommends that balanced audio connections always be used. Because the 2108's output connections are in parallel, it does not matter which connection you use, as there is no sonic difference.

The 2108 has balanced audio connections via XLR jacks. If you are connecting the 2108 to a preamplifier or amplifier that does not have balanced input connections, you will either need a pair of Boulder XLR-to-RCA adaptors (ABL2) or need to have your cables properly terminated. A diagram for the proper cable configuration is shown below.

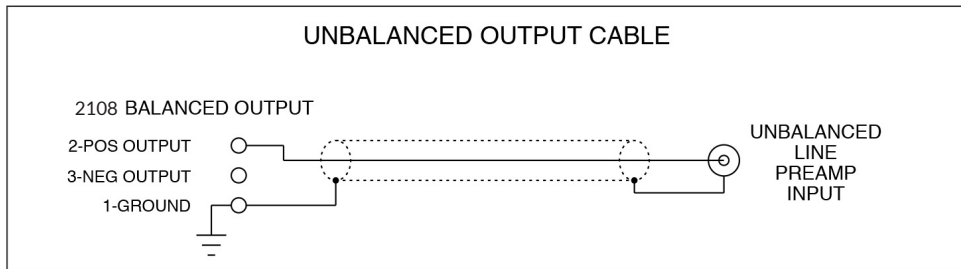

# Getting Started

---

## Connection to AC Mains

Connect the AC power cord to the 2100's AC Mains Connection and plug it into your AC mains wall outlet.

**WARNING:** *It is important never to disconnect any of the DC power cables when the unit is powered **ON** via the AC master power switch or damage may occur, even when the 2108 is in Standby mode!*

*Always turn the unit **OFF** from the rear panel of the 2100 power supply or disconnect the AC mains power cord **before** disconnecting any of the DC power cables.*

# Getting Started

---

## **Turntable Connection Types**

To get started listening, you only need to connect a turntable to the 2108 as you would any other phono preamplifier. Please take note of the following:

The 2108 can be connected to many different types of turntables. To fully realize the sonic potential of your 2108 Phono Preamplifier, use balanced cable connections with XLR terminations whenever possible. Balanced XLR cables minimize interference from magnetic, hum, and RF sources.



# Getting Started

## Connecting a Turntable

Because a phono cartridge is actually a balanced source, balanced inputs are provided on the 2108. Connect the output cables from your turntable to the **LEFT** and **RIGHT CHANNEL INPUT 1** connections of the 2108.

For turntables or systems that have more than one tonearm connection, connect the additional phono sources to the left and right connections for **INPUT 2** and **INPUT 3**.

Please note the following instructions to avoid picking up hum in the system:

Do not short pin 1 (chassis/ground) to either pin 2 or 3 of the XLR connector at any point in the cable, turntable chassis, or tonearm. This will cause hum in the system. Pins 2 and 3 must only be connected directly to the cartridge pins. Proper wiring diagrams are shown on the next page.

Use only a connection from Pin 1 of the turntable's XLR connector to the turntable chassis or the provided ground wire from the 2108's rear panel Ground Binding Post to the turntable chassis. Using both may form a ground loop, which will cause hum.

If your turntable does not have XLR connections, one pair of Boulder **PHRCA** Phono Adaptors is provided. These will convert the 2108's inputs to RCA and give acceptable performance. A separate ground wire is also provided.

**CAUTION:** *If your turntable does not have XLR connectors, do not use the Boulder ABL2 input adaptor or any other "standard" RCA to XLR adaptors. These are not intended for phono use, as they short pin 1 to pin 3 and will cause hum in your system. Only use the Boulder PHRCA Phono Adaptors.*  
**UNBALANCED RCA CABLE, PIN 2+ INPUT, PIN 3- INPUT, PIN 1**

# Getting Started

## GROUND

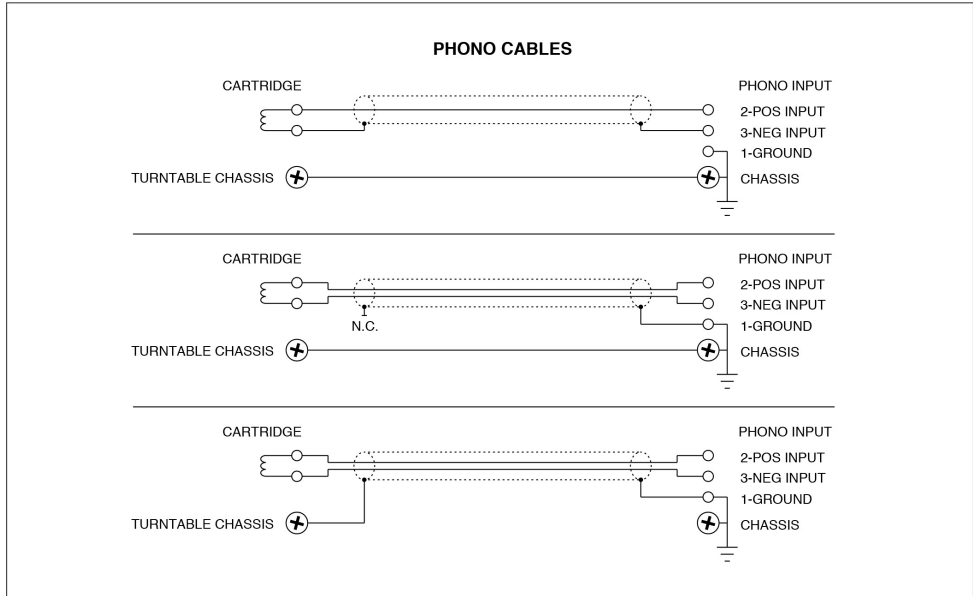

# Getting Started

---

## Connections

### Connecting a Cartridge Demagnetizer

The 2108 is able to connect an external cartridge demagnetizer to your phono cartridge via a pair of RCA connectors on the rear panel.

Connect each channel of the demagnetizer to the RCA inputs labeled **DEMAG** on the rear panel of the 2108.

**WARNING:** *Do not demagnetize a moving magnet (MM) cartridge or damage to the cartridge will occur!*

For Further information about the demagnetizer circuit, please see pages 1-24 and 2-5.

# Getting Started

---

## Connecting the Outputs to a Balanced Preamplifier

The 2108 has balanced output connections on XLR jacks. With the low output impedance of the 2108 Phono Preamplifier, distances of more than **100** meters between the 2108 and preamplifier or integrated amplifier are practical.

Connect the **LEFT** and **RIGHT OUTPUT** interconnects from the 2108 to your preamplifier or integrated amplifier's left and right inputs. To maintain the best sound quality, Boulder recommends that balanced interconnections always be used. Because the 2108's dual output connections are in parallel, it does not matter which connection you use, as there is no sonic difference between the two.

# Getting Started

## Connecting the Outputs to an Unbalanced Preamplifier

If you are connecting the 2108 to a preamplifier or amplifier that does not have balanced input connections, you will either need a pair of Boulder XLR-to-RCA adaptors (**ABL2**) or need to have your cables properly terminated. A diagram for the proper cable configuration is shown below.

This cable connects pin 1 of the XLR to the shield of the cable and pin 2 to the center pin of the RCA. It leaves the negative output (pin 3) unconnected.

Connecting the unused output pin (usually pin 3) to ground will cause excessive ground currents and degrade performance. Use an ohm meter or continuity checker to determine how your cable is wired.

**NOTE:** The 2108 Phono Preamplifier conforms to the standard of pin 2 as high or “hot” for all balanced analog inputs and outputs.

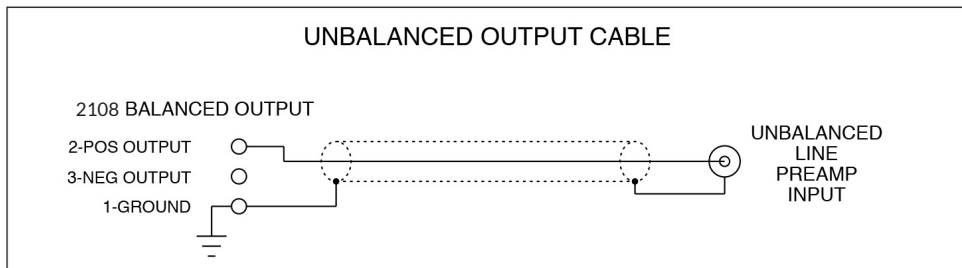

# Getting Started

## Setup and Loading

### Personality Cards

Each input connector of the 2108 has a slot below it for a Personality Card, one for the left and right channels of each input. These cards have four functions:

1. Selection of the type of cartridge to be used with the input (MC or MM)
2. Adjustment of the loading for the cartridge to be used with the input (resistive or capacitive)
3. Determining the gain level of the input
4. Enabling the Demagnetizer pass-through function (if selected)

On each Personality Card there is a DIP switch selector for choosing the cartridge type, gain level, and enabling demagnetizing.

***WARNING: Always press the Standby button on the front panel to place the 2108 in Standby mode before removing or installing any Personality Card! Failure to place the unit in Standby may result in very loud pops through the system!***

To remove a Personality Card, pull the tab on the card until it slides out of the rear panel. You may have to pull hard to remove the card. To install a Personality Card, push it into the rear panel until it is completely seated and the face of the card is flush with the rear panel.

# Getting Started

---

## Moving Coil or Moving Magnet Selection

Set the **Cartridge Type DIP Switch** to either **MC** (Moving Coil) or **MM** (Moving Magnet), depending on the type of cartridge mounted to your turntable.

From the factory, the Personality Cards for **INPUT 1** and **INPUT 2** are set to the **MC** position. When the Cartridge Type DIP Switch is set to the MC position, an additional low-noise 20 dB gain stage is inserted at the input for a total of **60** or **70 dB** of gain, depending on the setting of the Gain Selection switch.

The Personality Card for **INPUT 3** is set to the **MM** position. This is the most common setting for moving magnet cartridges. Total gain in the MM position is **40** or **50 dB**, depending on the setting of the Gain Selection switch.

# Getting Started

## Cartridge Loading Adjustment - Resistive

Set the **Cartridge Type DIP Switch** to either **MC** (Moving Coil) or **MM** (Moving Magnet), depending on the type of cartridge mounted to your turntable.

From the factory, the Personality Cards for **INPUT 1** and **INPUT 2** are set to the **MC** position and the resistive cartridge loading is **100Ω**, with a maximum unadjusted load of 1000Ω (no resistor installed). When the Cartridge Type DIP Switch is set to the MC position, an additional low-noise 20 dB gain stage is inserted at the input for a total of **60** or **70 dB** of gain, depending on the setting of the Gain Selection switch.

The Personality Card for **INPUT 3** is set to **MM** and no additional loading resistor is installed, so the resistive cartridge loading is **47kΩ**. This is the most common setting for moving magnet cartridges. Total gain in the MM position is **40** or **50 dB**, depending on the setting of the Gain Selection switch.

For **MC** cartridges the maximum resistive loading is **1000Ω**. This is the value when there is no resistor installed in position **R1** of the Personality Card. This value can be lowered by installing a resistor in position R1. The value for the load when a resistor is installed is calculated by the following:  $R1 = 1/(1/R_{DESIRED} - .001)$  or by using the following table.

Desired Cartridge Loading Value	Resistor Value To Install in Position R1
50 ohms	53 ohms
75 ohms	81 ohms
100 ohms	111 ohms
125 ohms	143 ohms
150 ohms	176 ohms



# Getting Started

Desired Cartridge Loading Value	Resistor Value To Install in Position R1
175 ohms	212 ohms
200 ohms	250 ohms
225 ohms	290 ohms
250 ohms	333 ohms
275 ohms	379 ohms
300 ohms	429 ohms
325 ohms	481 ohms
350 ohms	538 ohms
375 ohms	600 ohms
400 ohms	667 ohms
425 ohms	739 ohms
450 ohms	818 ohms
475 ohms	905 ohms
500 ohms	1000 ohms
525 ohms	1105 ohms
550 ohms	1222 ohms
575 ohms	1353 ohms
600 ohms	1500 ohms
625 ohms	1667 ohms
650 ohms	1857 ohms
675 ohms	2077 ohms
700 ohms	2333 ohms
725 ohms	2636 ohms
750 ohms	3000 ohms
775 ohms	3444 ohms
800 ohms	4000 ohms
825 ohms	4714 ohms

# Getting Started

Desired Cartridge Loading Value	Resistor Value To Install in Position R1
850 ohms	5667 ohms
875 ohms	7000 ohms
900 ohms	9000 ohms
925 ohms	12333 ohms
950 ohms	19000 ohms
975 ohms	39000 ohms
1000 ohms	Open (no resistor installed)

For **MM** cartridges, the maximum resistive load is **47kΩ**. This is the value when there is no resistor installed in position **R1** of the Personality Card. This value can be lowered by installing a resistor in position **R1**. The value for the load when a resistor is installed is calculated by the following:  $R1 = 1/(1/R_{\text{DESIRED}} - .0000213)$  or by using the table below:

Desired Cartridge Loading Value	Resistor Value To Install in Position R1
1000 ohms	1020 ohms
5000 ohms	5620 ohms
10000 ohms	12700 ohms
20000 ohms	34800 ohms
47000 ohms	Open (no resistor installed)

# Getting Started

## Cartridge Loading Adjustment - Capacitive

The 2108's inputs have “parasitic” capacitance of less than 50 pF directly across the cartridge inputs. If desired, additional capacitance can be added on the Personality Card at position **C1**. The selected capacitor value should be 50 pF less than the desired value.

Solder holes are provided for two different sizes of capacitors. There are two pairs of solder holes provided, as shown. Each left or right pair is connected together so that it does not matter which pair you use. The capacitor must only be soldered to one of the left and one of the right holes.

All solder joints on the Personality Card have grommets installed to reinforce the solder joint when parts are added or removed. Do not remove these grommets.

**NOTE:** *While some cartridge manufacturers may recommend additional capacitive loading, we suggest that you do not do so. Additional capacitance lowers the resonant frequency of the capacitor and the cartridge winding inductance, particularly with MM cartridges while the resonance peak remains just as high and will increase distortion.*

*Instead, we suggest trying a lower resistor value. The lower the value, the “heavier” the load and the lower the resonance peak (not frequency), which will give better damping to the cartridge.*

*With low-level MC cartridges there is practically no effect with capacitive loading, as the cartridge output impedance is inherently very low.*

# Getting Started

---

## Gain Selection Adjustment

The middle switch on the **Cartridge Type DIP Switch** can be set to either **LO GAIN** or **HI GAIN** (+10 dB). This switch is used to raise the overall gain of the input for lower output cartridges. When using cartridges with very low output (less than 0.2 mV), it is recommended that the HI GAIN setting is used.

If you do not know which setting to use, try the HI GAIN setting first. If you have to significantly reduce the volume of your preamplifier in comparison to other inputs, then the LO GAIN setting should be used to ensure that you do not overload the input of your preamplifier.

# Getting Started

---

## Demagnetizer Pass-Through Selection

A pair of RCA connectors on the rear panel of the 2108 are provided for connection to an external cartridge demagnetizer. If you wish to demagnetize a cartridge connected to a particular input of the 2108, set the **Cartridge Type DIP Switch** to **DEMAG OK**. If you will not connect a cartridge demagnetizer to the input, set the switch to **NO DEMAG**.

## Power

With all of the connections and adjustments made, you are now ready to listen to your Boulder 2108 Phono Preamplifier.

To turn the 2108 **ON**, move the **Master AC Power Switch** located on the rear panel of the 2100 Power Supply **upwards**. The 2108 will then go into Standby mode.

To bring the 2108 out of Standby mode, press the **STANDBY** button on the front panel. The LED above the STANDBY button will illuminate **white** and the 2108 will be powered on.

To turn the 2108 **OFF**, move the **Master AC Power Switch** located on the rear panel of the 2100 Power Supply **downwards**. The LED on the front panel of the power supply will not be illuminated when the 2108 is turned OFF.

# Operation

---

## Standby

To bring the 2108 out of Standby mode, press the standby button on the front panel. The LED on the front panel of the 2100 Power Supply will turn **white** and the 2108 will automatically unmute when it is ready for listening.

To place the 2108 in Standby mode, press the Standby button on the front panel. The LED on the front panel of the 2100 Power Supply will no longer be illuminated and the 2108 will go into power saving mode.

## Mute

The Boulder 2108 Phono Preamplifier provides an output muting feature that is turned on by four different conditions. When the 2108 is in Mute mode, the small LED above the MUTE button will illuminate **amber**.

First, the outputs are muted for three seconds when the 2108 is powered **ON**. Pressing the **MUTE** button while the 2108 is in this state will have no effect.

Second, the outputs can be temporarily muted at any time for your convenience. To temporarily mute the outputs, press the front panel **MUTE** button. Pressing the **MUTE** button a second time will unmute the 2108's outputs.

Third, the outputs of the 2108 will automatically be muted for **three** seconds when an **INPUT** or **EQUALIZATION** button is pressed. After three seconds, the outputs will automatically unmute and operation will return to normal.

Fourth, when the 2108 is turned **OFF**, the outputs will be muted.



# Operation

---

## Input Selection

The Boulder 2108 Phono Preamplifier provides three pairs of inputs for use with three different phono cartridges from one or more turntables.

To select an input, press one of the **INPUT** buttons on the front panel of the 2108. The LED above the selected input will turn **white**. When changing inputs, the 2108 will mute the outputs for three seconds.

**NOTE:** Do not select an input that does not have a cartridge connected. If it is necessary to disconnect all of the inputs, the **MUTE** button should be pressed or the 2108 should be placed in Standby mode.

## Demag

Some moving coil cartridge manufacturers have an external accessory used to demagnetize their particular phono cartridge. The 2108 includes a convenient circuit that allows this accessory to be used without having to disconnect any of the input connections.

**WARNING:** *Do not demagnetize a moving magnet (MM) cartridge or damage to the cartridge will occur! Boulder assumes no liability for cartridges damaged by the improper use of the Demagnetizer function.*

To enable use of the Demagnetizer pass-through, an external cartridge demagnetizer appropriate for your particular cartridge must be connected to the Demagnetizer inputs on the rear panel of the 2108 and the **DEMAG** switch on the input's Personality Card must be set to **DEMAG OK**.

Select the input for the cartridge to be demagnetized by pressing the button for that input, then press the **DEMAG** button on the front panel of the 2108. This will mute the outputs of the 2108. The LED above the **DEMAG** button will illuminate **red** and the LED above the **MUTE** button on the front panel will be illuminated **amber**. You can then turn on and operate the cartridge demagnetizer as per the demagnetizer manufacturer's instructions. When the demagnetizer's operation is complete, press the **DEMAG** button again. The DEMAG LED will no longer be illuminated and the inputs will once again be connected to the cartridge. After three seconds the **MUTE** LED will turn off and operation will return to normal.

When in use, only the inputs with Personality Cards set to DEMAG OK will be connected to the cartridge demagnetizer through the 2108.

**WARNING:** *Always turn the system volume all the way down or mute the preamplifier when using the Demagnetizer function of the 2108!*

# Operation

---

## Mono

When played with a stereo cartridge, monaural or “mono” recordings can be enhanced by mixing the left and right channels to create a true monaural audio signal. It is possible to do this with the 2108 by putting the unit in MONO mode.

When the **MONO** button on the front panel of the 2108 is pressed, the LED above the MONO button will illuminate **amber** to indicate that the Mono circuit is active.

To return the 2108 to stereo operation, press the MONO button on the front panel and the LED will no longer be illuminated.

## Equalization

The Boulder 2108 Phono Preamplifier provides the standard **RIAA** equalization curve for recordings produced after 1955, along with the **EMI**, **Columbia**, and **FFRR** curves for records manufactured before 1955.

Select the equalization curve you wish to use by pressing the button labeled with the name of that particular curve. For example, pressing the “RIAA” button will activate RIAA equalization.

The three remaining curves may be selected by pressing the button labeled with their respective names. When active, the LED above the RIAA button will be illuminated **amber**. All other EQ options will illuminate **white**.

When changing equalization settings, the 2108 will immediately mute the outputs and the **MUTE** light will illuminate **amber** for 3 seconds. After that time, the output will be unmuted and the MUTE indicator will turn off.

# Operation

## RIAA REPRODUCE EQUALIZATION

REF 0 DB AT 1 KHZ

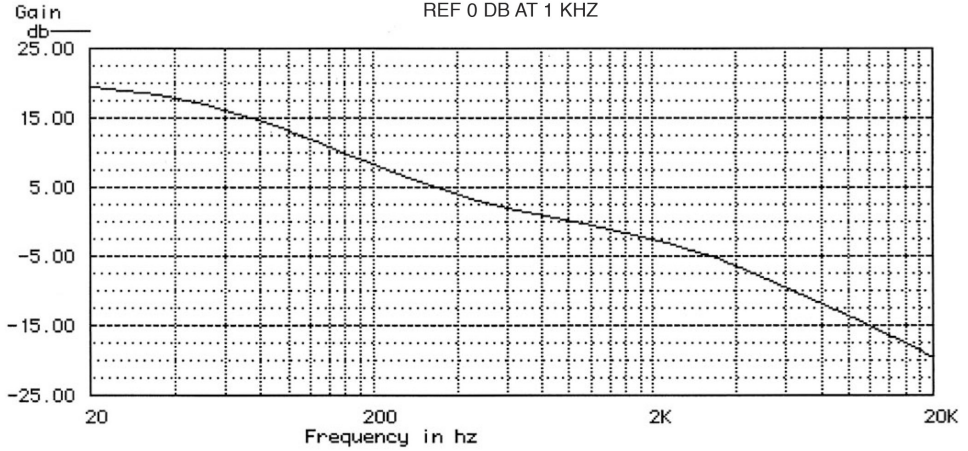

## FFRR REPRODUCE EQUALIZATION

REF 0 DB AT 1 KHZ

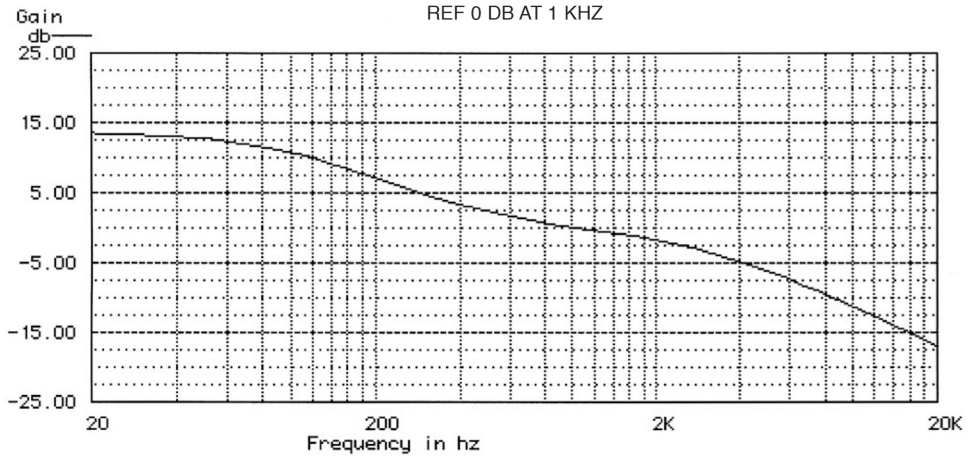

# Operation

**EMI REPRODUCE EQUALIZATION**  
REF 0 DB AT 1 KHZ

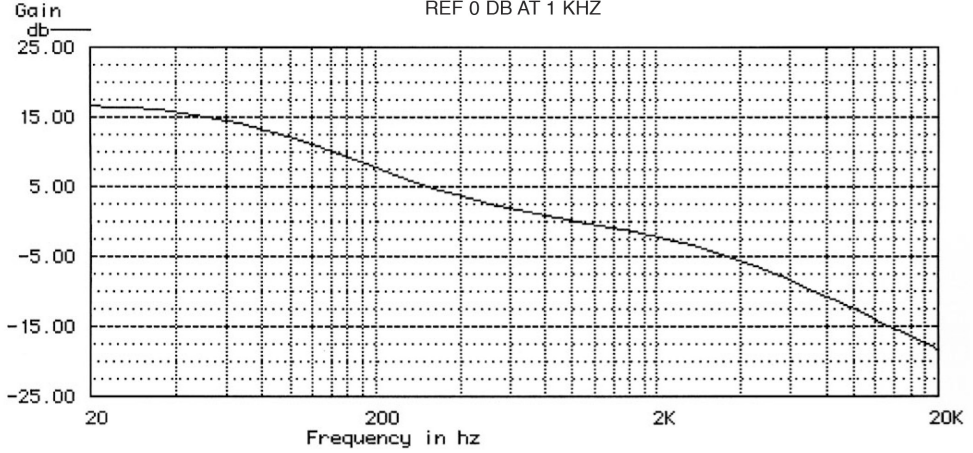

**COLUMBIA REPRODUCE EQUALIZATION**  
REF 0 DB AT 1 KHZ

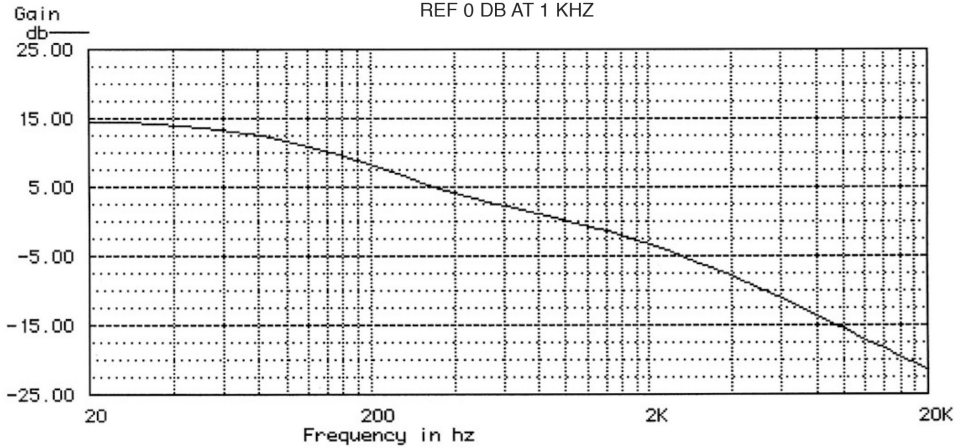

# Operation

---

## Low Cut Filter

The Boulder 2108 Phono Preamplifier uses a 3-pole (18 dB/octave) low cut filter that may be switched to one of two frequencies or can be turned off. When the Low Cut circuit is activated, response will be -3 dB at 10 Hz or 20 Hz.

Because this filter is fairly steep, its effect is virtually negligible in the audio band. It is recommended that it be kept turned on in order to avoid excessive woofer travel caused by warped or damaged records.

Select the low cut filter point by pressing the **10 Hz** or **20 Hz** button. The indicator above the button will illuminate **white**.

To completely turn off the filter, press the button labeled **OUT**. The low cut filter will be deactivated and the LED indicator will turn off.

**WARNING:** *Due to the low frequency content of some recordings, care should be taken with the volume level when turning the low cut filter ON or OFF as there may be an audible transient or click through the loudspeakers. This effect is normal.*

## Recording

### Connections

The 2108 Phono Preamplifier has two pairs of outputs. These outputs are connected in parallel, so there is no benefit to using one pair of outputs over the other.

When one pair of outputs is connected to a preamplifier, the second pair of outputs can be connected to a recording device. It is possible to use balanced or unbalanced connections for both inputs and outputs as described in Section 1, “Connections.”





# Appendix

## Technical Specifications

Inputs	3 x 3-pin balanced XLR, adaptable to unbalanced
Outputs	2 x 3-pin balanced XLR, adaptable to unbalanced
Input Impedance	MC: maximum 1000 $\Omega$ , MM: 47k $\Omega$ . Resistive and capacitive loading adjustable on individual Personality Cards.
Output Impedance	100 $\Omega$ Balanced
Maximum Output Level	28 Vrms
Distortion, THD	0.005%
1 kHz Gain, RIAA	MC: 70 or 60 dB, MM: 50 or 40 dB
Noise (EIN), MC	160 $\mu$ V A-wtd, 275 $\mu$ V Flat, 20 Hz to 20 kHz
Frequency Response, 20 Hz to 20kHz	RIAA: $\pm$ 0.10 dB
Crosstalk, L to R or R to L	-100 dB or better, 20 Hz to 20 kHz
Power Requirements	90-120V / 200-240V, 50–60 Hz
Power Consumption	75W Max

*All specifications measured at 240 VAC mains Power*

# Appendix

---

## Dimensions and Weights

2108 Phono Preamplifier Chassis: 18" W x 15.5" D x 5" H  
45.7 cm W x 39.4 cm D x 12.7 cm H  
(37 lbs./16.8 kg)

2100 Power Supply Chassis: 18" W x 15.5" D x 4.25" H  
45.7 cm W x 39.4 cm D x 10.8 cm H  
48 lbs. (21.8 kg)

2108 Phono Preamplifier Shipping: 18" W x 16" D x 5" H  
47.5 cm W x 41 cm D x 12.7 cm H  
(51 lbs./23.2 kg)

2100 Power Supply Shipping: 24" W x 21" D x 12" H  
61 cm H x 54 cm D x 31 cm H  
69.5 lbs. (31.6 kg)

# Appendix

## 2108 Preamplifier Section Dimensions (Inches)

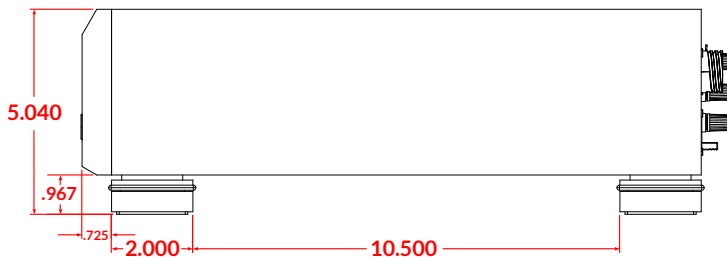
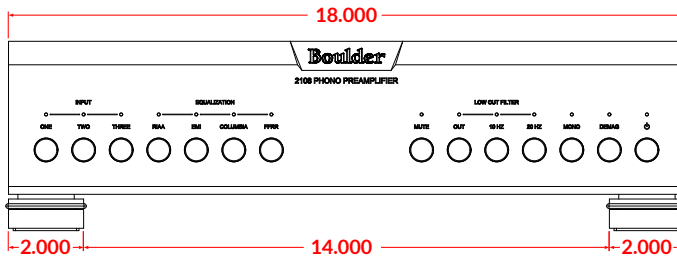
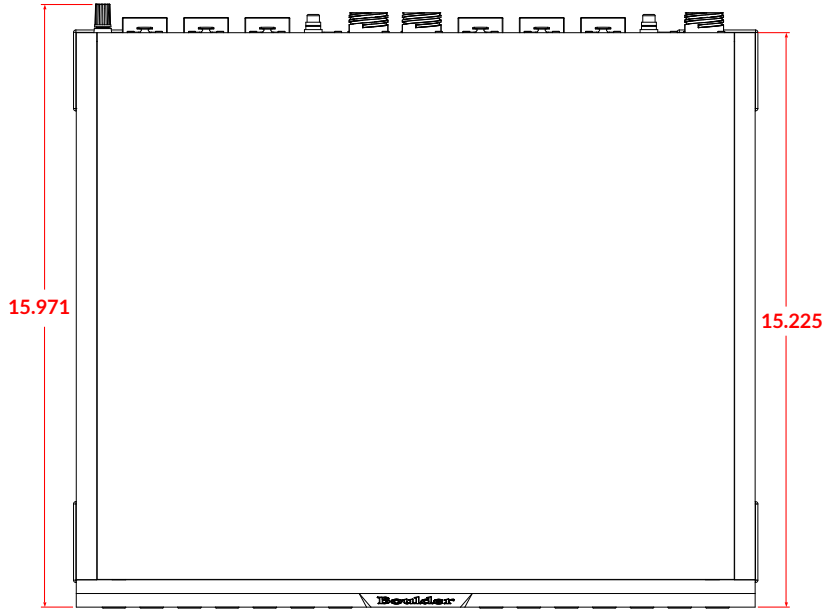

# Appendix

## 2100 Power Supply Section Dimensions (Inches)

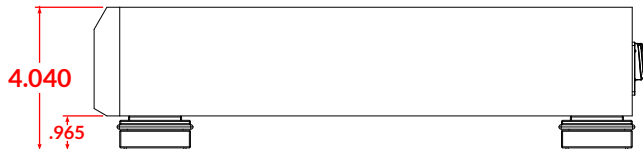
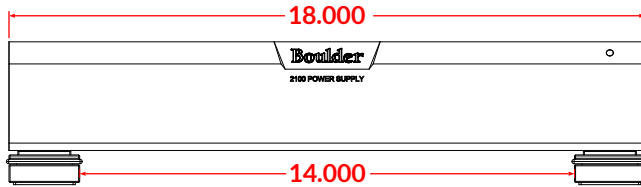
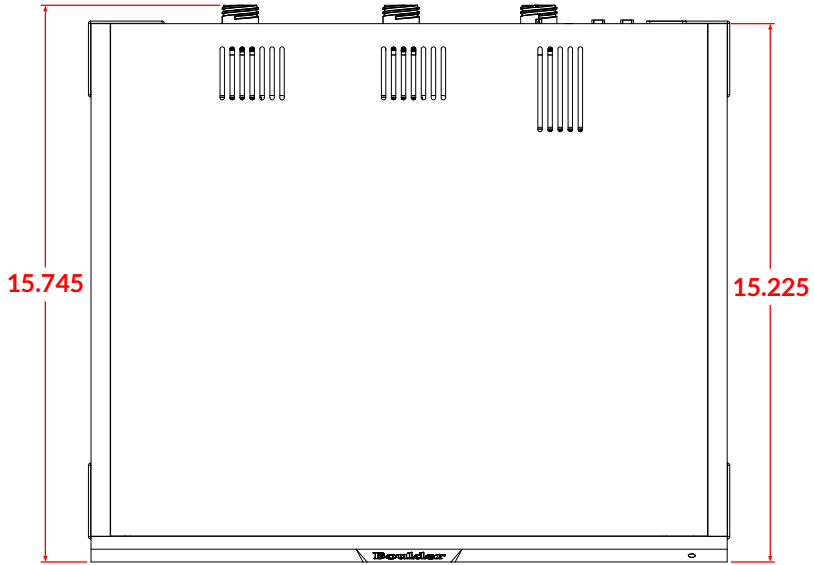

# Appendix

SYMPTOM	CAUSE	REMEDY
No power indication on 2100	Power Switch is not in ON position	Move Power Switch to ON position
	2108 is not plugged in	Connect power cord to AC mains outlet
	Home circuit breaker is tripped	Reset home circuit breaker
	Low line voltage	Have line voltage checked
	Defective power cable	Have power cable tested or replaced
	Defective 2108	Return 2108 to dealer for service
Red LED indicator on 2100	Phono preamplifier is booting up	Wait until boot process completes
	Defective power supply	Return 2100 and 2108 to dealer for service
	Defective 2108 phono preamplifier	Return 2100 and 2108 to dealer for service
	No signal from one channel of turntable	Check turntable cables and connections
White power indication, but no sound	No signal out to preamplifier	Check cables and connections to preamplifier
	2108 is Muted, MUTE LED ON	Push MUTE button to turn Mute function OFF
	No ground connection	Check or install ground wire
Hum through loudspeakers	Duplicate ground connection	Use only one ground wire to turntable or use the ground in a balanced cable
	2108 or turntable is too close to another component or power supply	Move 2108 and/or turntable away from power supply
	Partial or bad connection at phono cartridge	Check and/or correct connections at phono cartridge

# Appendix

---

One channel louder than the other	GAIN switches not set equally	Set GAIN switches on Personality Cards to same setting
	MC/MM switches no set equally	Set MC/MM switches on Personality Cards to same setting
	Cartridge loading is not set equally	Check cartridge loads on Personality Cards





